









melford **FALCON SELF-SERVICE KIOSK**

The Falcon offers a slim, robust solution that provides a secure platform whilst maintaining a small footprint. The customer experiences a fully interactive solution where a self-service kiosk solution is required ensuring clients are served quickly reducing waiting time and providing considerably more throughput efficiency and uplifts in turnover and profit.

Running Android 12, the Falcon range features 15" or 22" high-resolution P-CAP touch screens, powered by a RK-3568 Quad Core Cortex A55 processor. Solutions are available in 4x3 or 16x9 aspect ratios and can be used in portrait or landscape orientation.

KEY FEATURES

-  True-Flat P-CAP touch
-  Quad core processor
-  Portrait or landscape orientation
-  Range of screen size options
-  Various mounting options
-  Optional 1D/2D barcode scanner
-  Optional receipt printer
-  Optional payment devices

melfordtechnologies.com

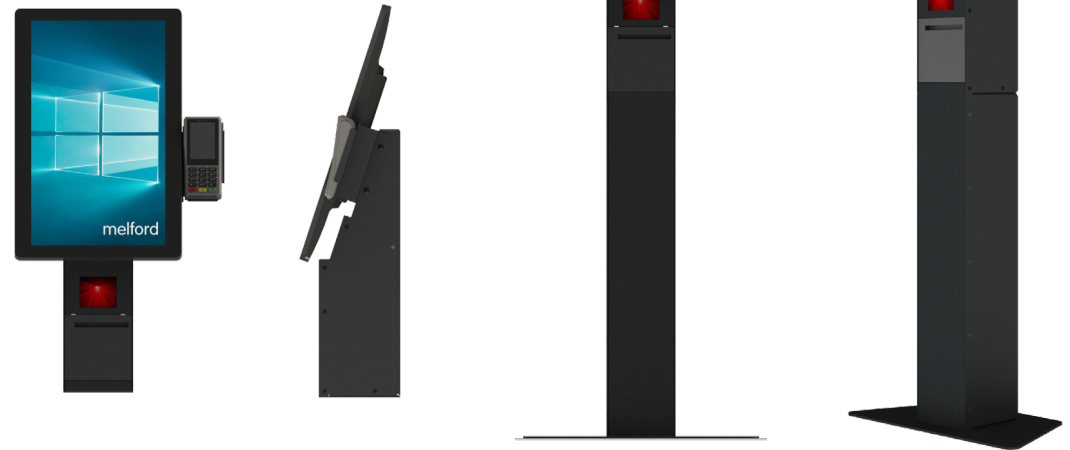

Presenting the Falcon range of modular, self-service kiosks

melford

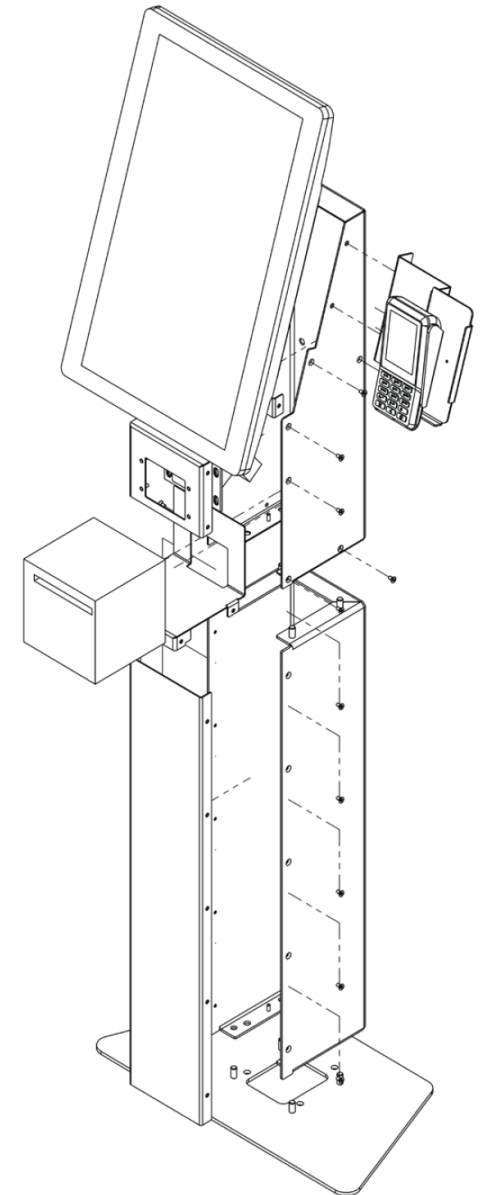
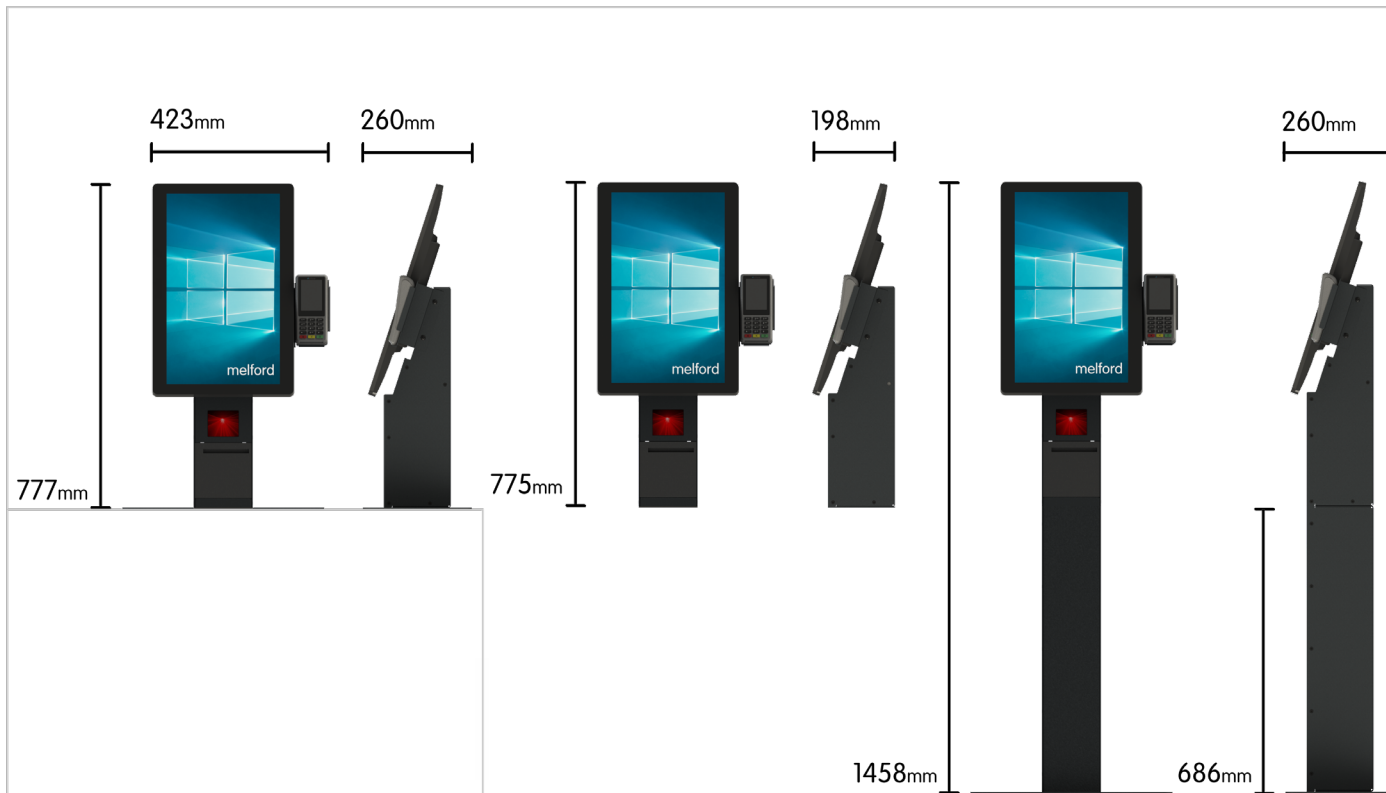

The Falcon range is available with a free-standing floor plinth, desktop mount, or wall mount. It is suitable for self-service, click and collect, customer or patient check-in, or for use in a QSR environment. The modular flexibility of the solution means it can be used in retail, hospitality, leisure, attractions, corporate and healthcare.

These self-service kiosks offer an optional 1D / 2D barcode scanner reading standard barcodes as well as vouchers and QR codes from the latest mobile devices. Receipts are generated from the integrated Epson printer (alternative printers are available on demand).

The latest chip and pin and contactless payment devices can also be utilised, including the Verifone VX820 and Ingenico Lane/3000 terminals and others on request.

melford

Falcon Self-Service Kiosk (Android)

Processor	RK-3568 Quad Core Cortex A55-2.0Ghz
Memory	4GB
Storage	64GB Built-in eMMC
Connection	WiFi & Bluetooth
Speaker	2 x 2W Internal Speaker
Display Size	15" or 21.5"
Panel Resolution	1920 x 1080
Brightness	250 nits
MTBF	50,000 hours
Power	20V/90W or 20V/130W External Adapter (Power Rating 130W)
OS	Android 12
Touch Screen	True-Flat P-CAP touch
Temperature	Operation: 0°C ~ 40°C (32°F ~ 104°F) Storage: -20°C ~ 60°C (-4°F ~ 130°F)
2D Scanner (optional)	Zebra MS4717 Cone
Thermal Receipt Printer (optional)	Epson TM-M30ii, USB, Ethernet, NES or Star MCPrint3 - other printers available on request
Optional Peripherals	Holder for Verifone P400m, Ingenico Lane/3000, Verifone VX820, SumUp Air - other holders on request. NFC Reader
Dimensions (HxWxD)	Floor Standing: 1458mm x 423mm x 260mm Wall Mounted: 775mm x 423mm x 198mm Desk Mounted: 777mm x 423mm x 260mm
Weight (kg)	Floor Standing: 27.3kg Wall Mounted: 14.8kg Desk Mounted: 18.4kg
Accessories	3 Pin Plug, Network Cable

Why Melford?

Melford Technologies have been offering innovative technology solutions for over 50 years.

We provide experienced professional design, project planning, configuration, deployment, and maintenance services for a full one stop shop.

We can assist with the design and manufacture of your kiosk solution from the blank piece of paper at the initial meeting through to installation and post-sales support.

Contact Us

+44 (0)1494 638 069

info@melfordtechnologies.com

melfordtechnologies.com

